

ID	Description	Date	By	Appr.
A				

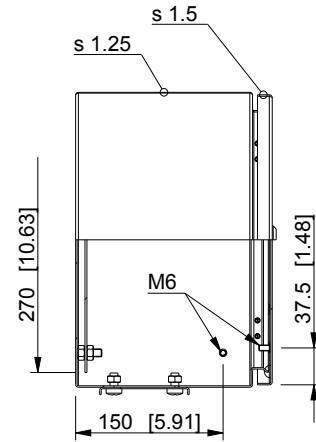
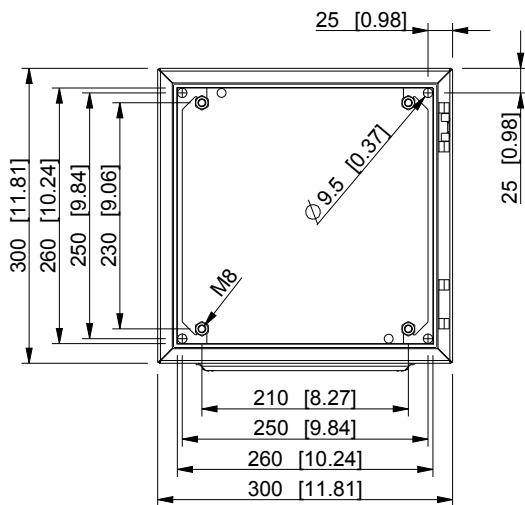
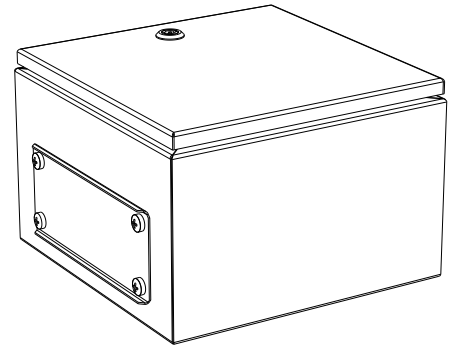
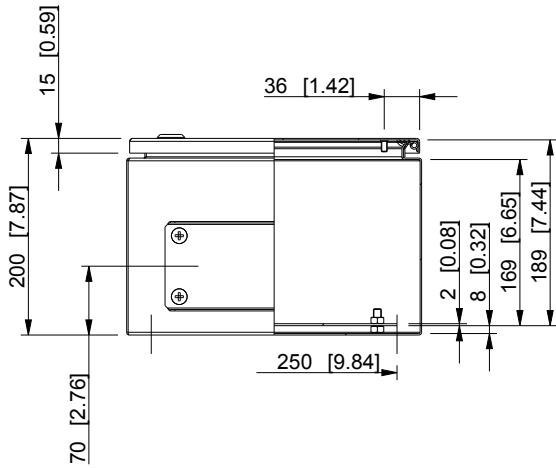

Flange opening, type 2 (C/FL21)

Dimensions in mm [inches]

Material: Mild steel, polyester painted	Color: RAL 7035
---	-----------------

Supplier: -	Tool No: -	Weight [kg]: 6.63	Volume: -
-------------	------------	-------------------	-----------

model EFEF303020A PART drawing EFEF_1 DRAWING			<h1>EFEF303020A</h1>	Replaces:	
				Replaced:	
	Scale	Date		07.07.16	Drw No: A
	2:15	By		PLe	Ref: Cubo E
	-	Checked			Code: EFEF303020A
-	Ctrl		Sheet No:		