

ID	Description	Date	By	Appr.
A				

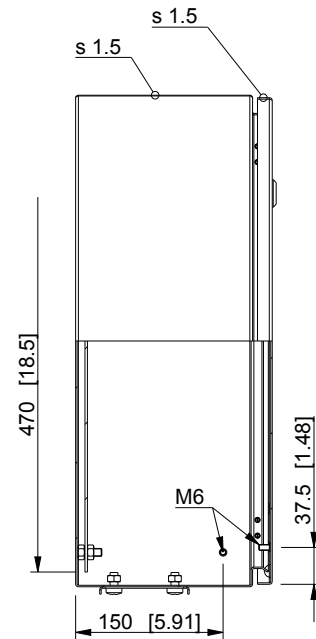
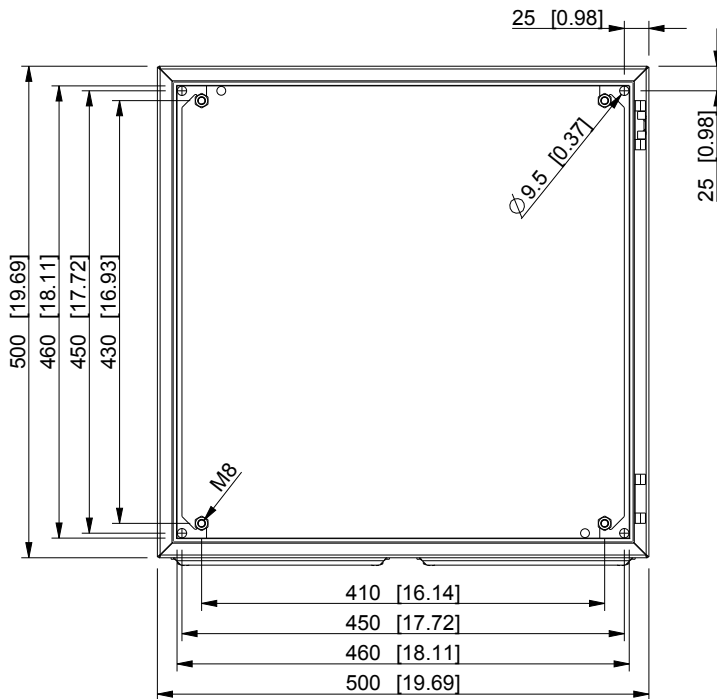
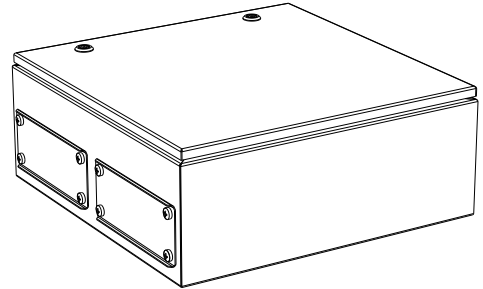
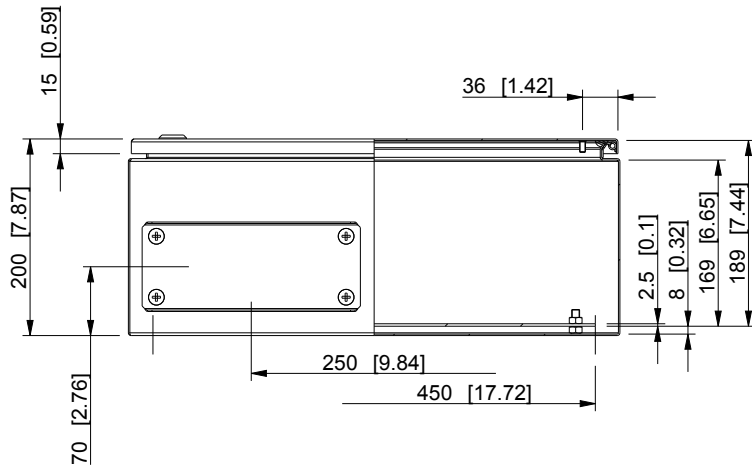

Flange opening, type 2 (C/FL21)

Dimensions in mm [inches]

Material: Mild steel, polyester painted	Color: RAL 7035
---	-----------------

Supplier: -	Tool No: -	Weight [kg]: 15.86	Volume: -
-------------	------------	--------------------	-----------

CASEMET		
Casemet Oy		
Scale	Date	07.07.16
2:15	By	PLe
-	Checked	
-	Ctrl	

EFEF505020A	
Replaces:	
Replaced:	
Drw No:	A
Ref:	Cubo E
Code:	EFEF505020A
Sheet No:	

model EFEF505020A PART
 drawing EFEF_2 DRAWING