

ID	Description	Date	By	Appr.
A				

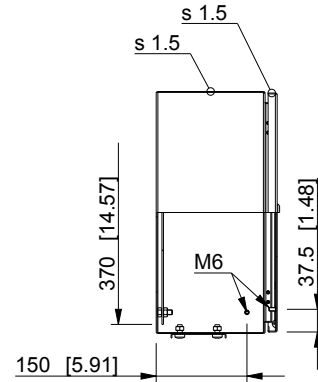
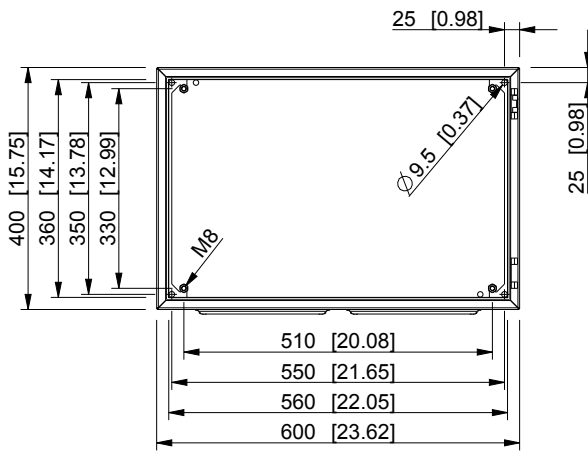
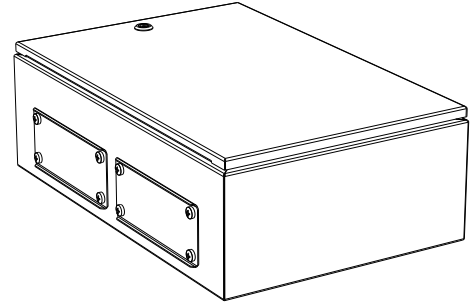
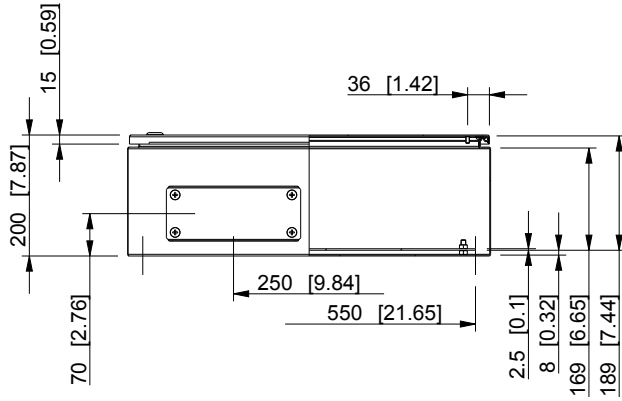

Flange opening, type 2 (C/FL21)

Dimensions in mm [inches]

Material: Mild steel, polyester painted	Color: RAL 7035
---	-----------------

Supplier: -	Tool No: -	Weight [kg]: 15.47	Volume: -
-------------	------------	--------------------	-----------

model EFEF604020A PART drawing EFEF_2 DRAWING			<h1>EFEF604020A</h1>	Replaces:
				Replaced:
	Casemet Oy			Drw No: A
	Scale	Date		Ref: Cubo E
	1:12	07.07.16		Code: EFEF604020A
-	By	Sheet No:		
-	Checked			
-	Ctrl			