

ID	Description	Date	By	Appr.
A				

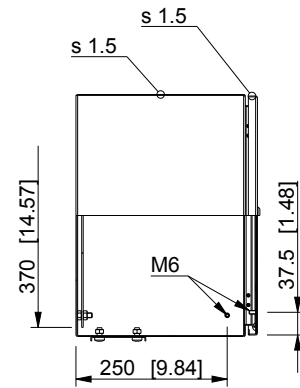
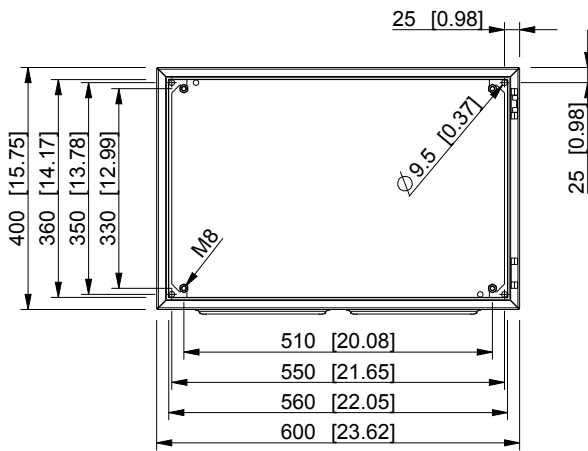
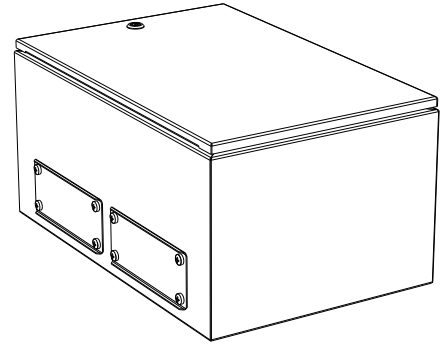
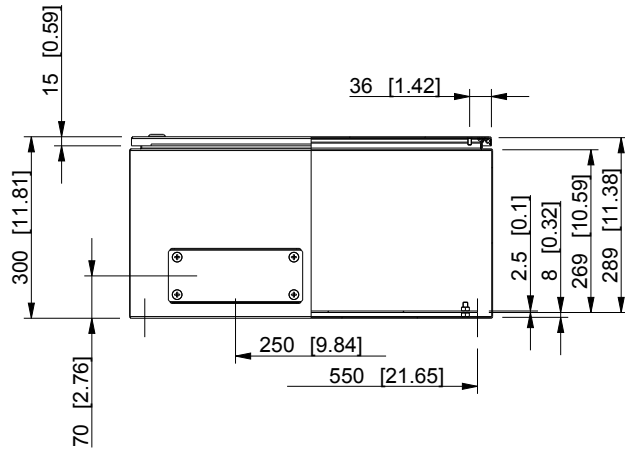

Flange opening, type 2 (C/FL21)

Dimensions in mm [inches]

Material: Mild steel, polyester painted	Color: RAL 7035
---	-----------------

Supplier: -	Tool No: -	Weight [kg]: 17.82	Volume: -
-------------	------------	--------------------	-----------

model EFEF604030A PART drawing EFEF_2 DRAWING			<h1>EFEF604030A</h1>	Replaces:
				Replaced:
	<b>Casemet Oy</b>			Drw No: <b>A</b>
	Scale	Date		Ref: <b>Cubo E</b>
	<b>1:12</b>	<b>07.07.16</b>		Code: <b>EFEF604030A</b>
-	By	Sheet No:		
-	Checked			
-	Ctrl			