

ID	Description	Date	By	Appr.
A				

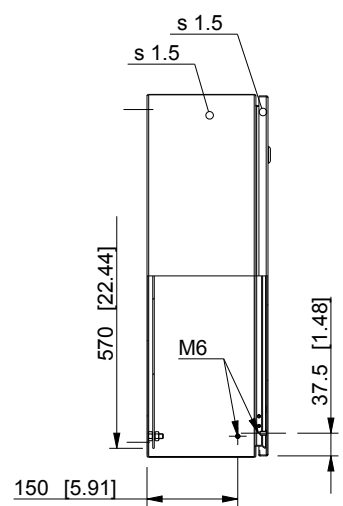
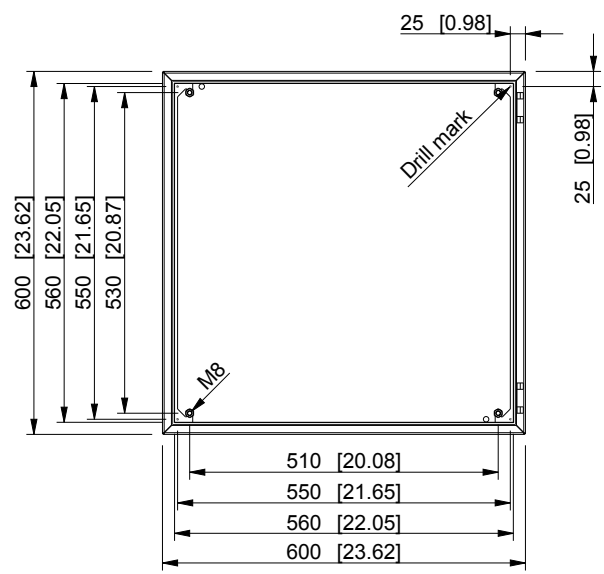
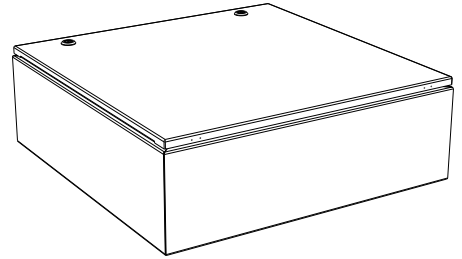
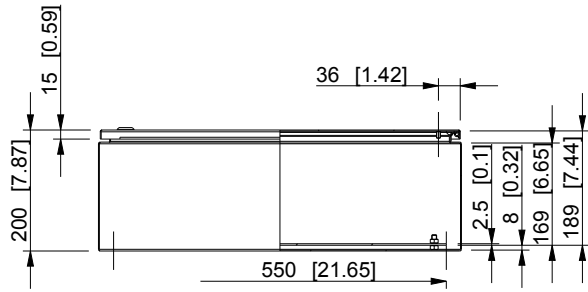

Dimensions in mm [inches]

Material: Stainless steel, AISI 304	Color: -
-------------------------------------	----------

Supplier: -	Tool No: -	Weight [kg]: 21.16	Volume: -
-------------	------------	--------------------	-----------

CASEMET
Casemet Oy

ESSP606020

Scale	Date	15.06.16
1:12	By	VLe
-	Checked	
-	Ctrl	

Replaces:	
Replaced:	
Drw No:	A
Ref:	Cubo E
Code:	ESSP606020
Sheet No:	

model ESSP606020 PART
drawing ESSP_1 DRAWING