

ISO 2768-C GENERAL TOLERANCES
LINEAR AND ANGULAR DIMENSIONS

DIN 6930-C STAMPED STEEL PARTS
FLAT SURFACES / BENDINGS

ISO 13920-BG WELDINGS
WELDED CONSTRUCTIONS

Model
Drawing VSSP303020.dwg

1 2 3 4 5 6 7 8

ID	Description	Date	By	Appr.
A	1.	23.7.18	PLe	

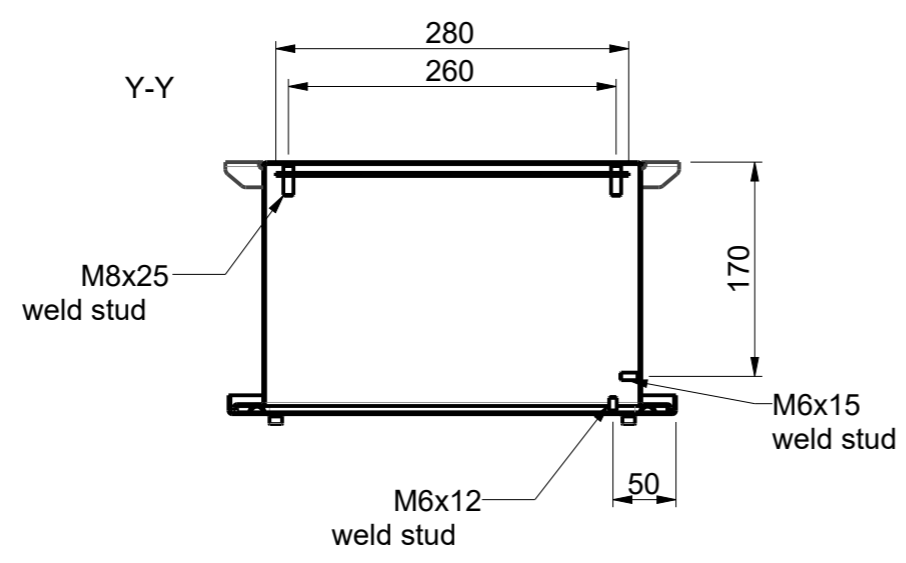
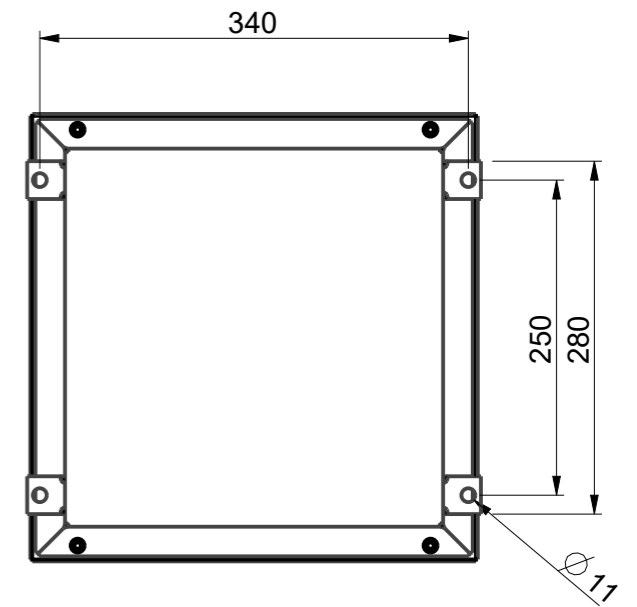
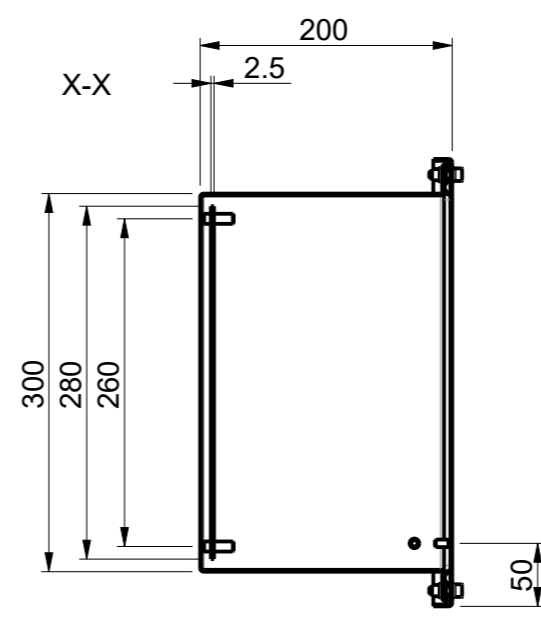
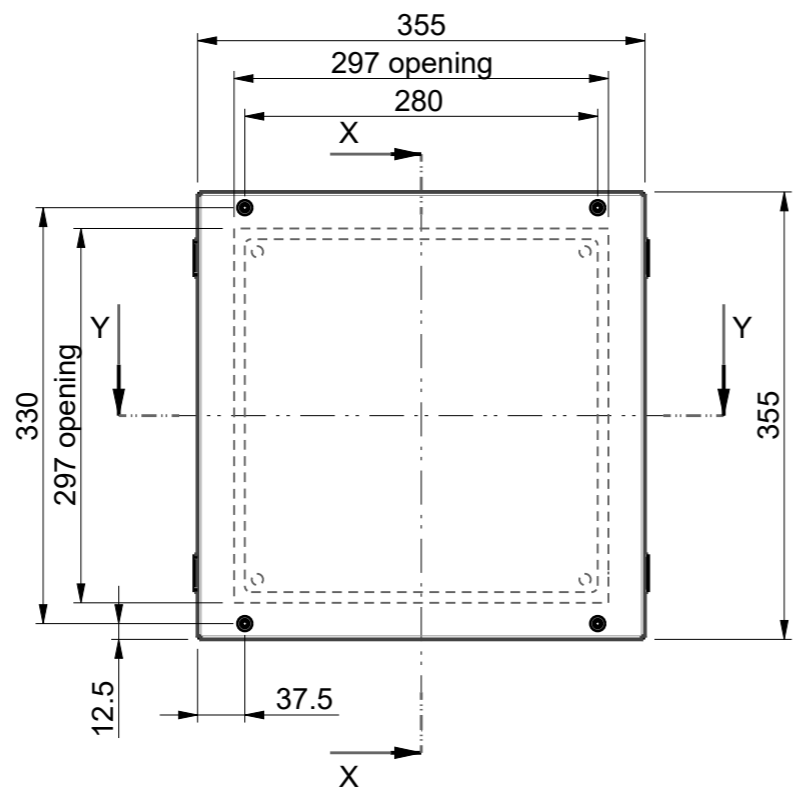
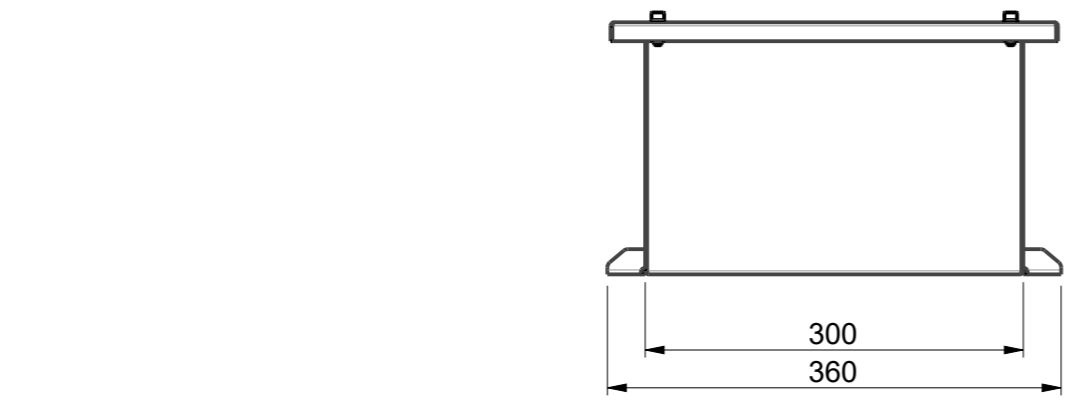

Part	Code	Description	Pcs	Weight [g/pcs]
5	PPE19208	Mounting Plate V3030	1	0
4	RST12108	Lid VSS3030	1	0
3	PLF33	DIN912 M6x20 A4 hex socket screw	4	0
2	PUA84	DIN125 M6 A4 Washer	4	0
1	RST12008	Base VSSP303020	1	0

Surface Treatment: Color: - Weight [g] 6000

Material: Stainless steel Casemet Material:

			Enclosure VSSP303020	Replaces:
Casemet Oy				Replaced:
Scale	Date	23.7.18	Drw No: A	Ref: Cubo V
1:6	By	PLe		Code: VSSP303020
A3	Checked			
Sheet No: 1 (1)	Ctrl			